

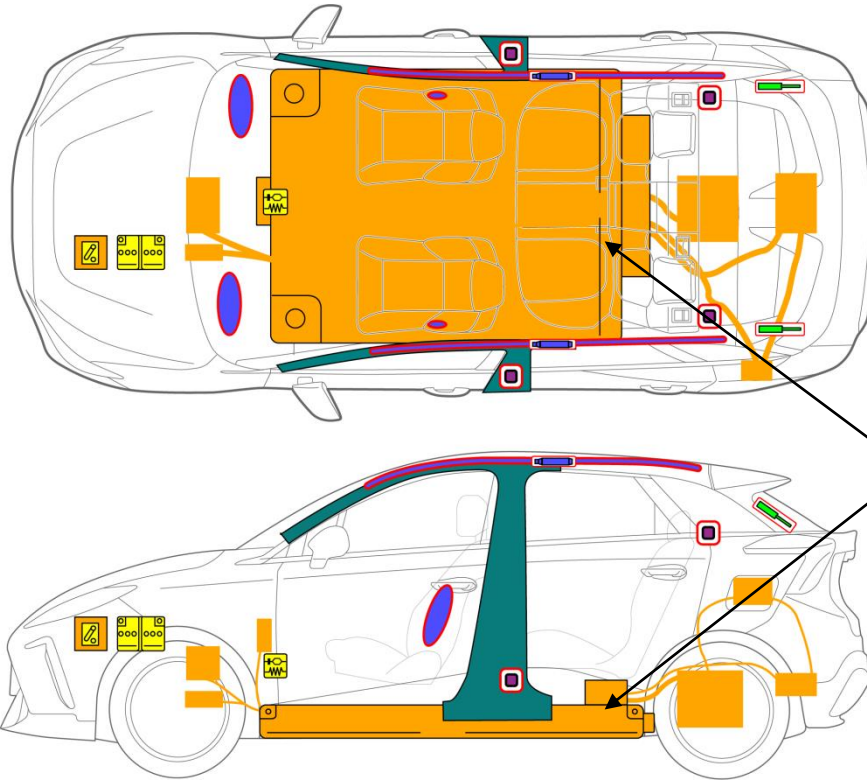

MG 4  
Electric, 2022-



Li-ion  
379.6V  
452.4V

	Airbag		Stored gas inflator		Seat belt pretensioner		SRS control unit		Pedestrian protection active system
	Automatic rollover protection system		Gas strut / Preloaded spring		High strength zone		Zone requiring special attention		
	Battery low voltage		Ultra capacitor, low voltage		Fuel tank		Gas tank		Safety valve
	High voltage battery pack		High voltage power cable / component		High voltage disconnect		Fuse box disabling high voltage system		Ultra capacitor, high voltage
	Disconnect high voltage device								
ID Nr.		Version Nr.		Version date		page			
MG 4 Electric		1.0		07/2022		Page 1 of 4			



## 1. Identification/Recognition



**A LACK OF MOTOR NOISE DOES NOT INDICATE THE SYSTEM IS OFF, A SILENT MOVEMENT CAPABILITY EXISTS UNTIL THE VEHICLE IS FULLY SHUT DOWN. ALWAYS WEAR APPROPRIATE PPE.**

### MG 4 ELECTRIC



### READY Indicator – Green



This lamp is used to indicate that the EV system is powered up and the vehicle is ready for driving.

**READY**

## 2. Immobilisation/Stabilisation/Lifting

### Immobilise the Vehicle

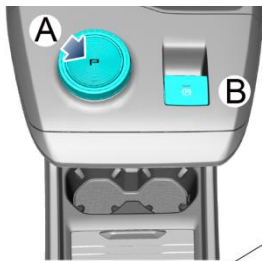

- A: Place in P position;
- B: Apply the EPB (indicator ON);
- C: Press Lock Button on the key to turn off the power system (indicator LED's are OFF).



### Jacking or Lifting

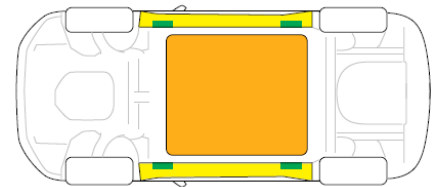

Appropriate lift areas      High voltage battery

Use caution to ensure you never come into contact with the high voltage battery or other high voltage components while lifting or manipulating the vehicle.

## 3. Disabling Direct Hazards / Safety Regulations

The vehicle power system can be shut down normally.

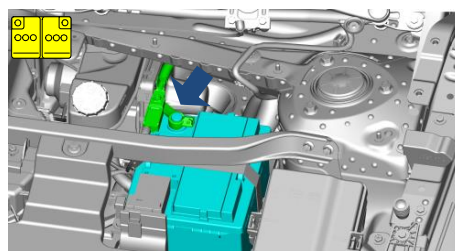
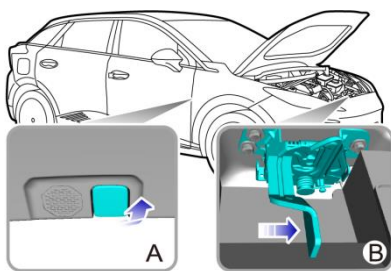

From the inside of the vehicle, pull the bonnet release handle(B), Move the safety catch release handle on the bonnet lock assembly in the direction of the arrow (A) to release the bonnet.

Power off and disconnect the negative cable of 12V low-voltage battery.

In cases of emergency, the high voltage system can be isolated by removing the manual service disconnect device (master safety device).

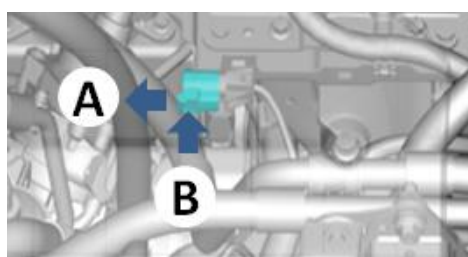
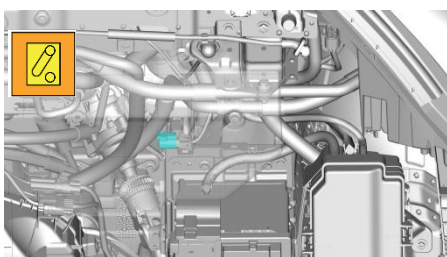

Open the bonnet, pull out the clip from the manual service disconnect(A), press the end of the clip (B) and remove the manual service disconnect.

ID Nr.	Version Nr.	Version date	page
MG 4 Electric	1.0	07/2022	Page 2 of 4



## 4. Access to the Occupants

ULTRA HIGH STRENGTH STEEL  
NO-CUT ZONES

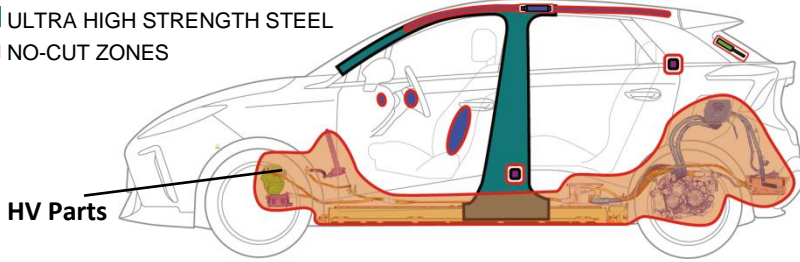

### Glass types

- Front window: Laminated glass
- Rear window: Tempered glass
- Four door : Tempered glass

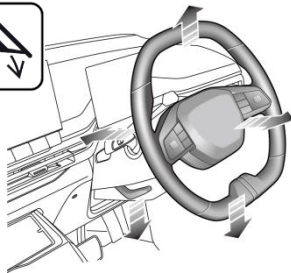

Fully release the locking lever, the steering wheel can be adjusted in 4 directions.



- 1、 Forward/Backward adjustment
- 2、 Cushion Height Adjustment
- 3、 Backrest Adjustment

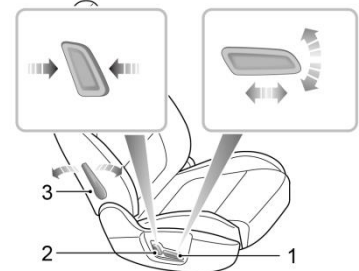

- 1、 Forward/Backward adjustment  
Cushion Height Adjustment
- 2、 Backrest Adjustment
- 3、 Lumbar Support Adjustment

## 5. Stored Energy / Liquids / Gases / Solids

		12V
		379.6V 452.4V
		Coolant:4/5.6L Refrigerant:660/580 g



The battery assembly cover should never be breached or removed under any circumstances, including fire. Doing so may result in severe electrical burns, shocks, or electrocution.



When coolant leaks from the battery pack, it can become unstable with a risk of thermal runaway. Check battery pack temperature with a thermal imaging camera.

## 6. In Case of Fire



USE LARGE AMOUNTS OF WATER.



BATTERY RE-IGNITION!



DO NOT SUBMERGE VEHICLE TO EXTINGUISH BATTERY.

- Wear a full set of insulated protection equipment and use specialized insulated tools.
- Disconnect the high-voltage output immediately when conditions permit.
- Continuously spray with a large amount of continuous water.
- Ensure the high-voltage battery is completely extinguished and cooled to avoid reignition.
- To recover the vehicle, do not tow it directly, use a rescue vehicle instead.

ID Nr.	Version Nr.	Version date	page
MG 4 Electric	1.0	07/2022	Page 3 of 4



## 7. In Case of Submersion

- Wear a full set of insulated protection equipment and use specialized insulated tools.
- Avoid touching the metal conductor of the damaged high-voltage device.
- If there is no hissing sound or foam being emitted by the high voltage battery pack, the vehicle can be salvaged by professional organizations.
- After recovery from deep or flood water the vehicle high voltage system must be isolated and placed in an open place for isolation.
- To transfer the vehicle, do not tow it directly but use a recovery vehicle instead.

## 8. Towing / Transportation / Storage

- Before towing the vehicle, release the parking brake, switch on the hazard warning lamps, close all doors and lock the vehicle.
- When towing, DO NOT suddenly accelerate or brake suddenly, this can cause accidents.
- Personnel are prohibited from staying in the vehicle when towing and transporting the vehicle.

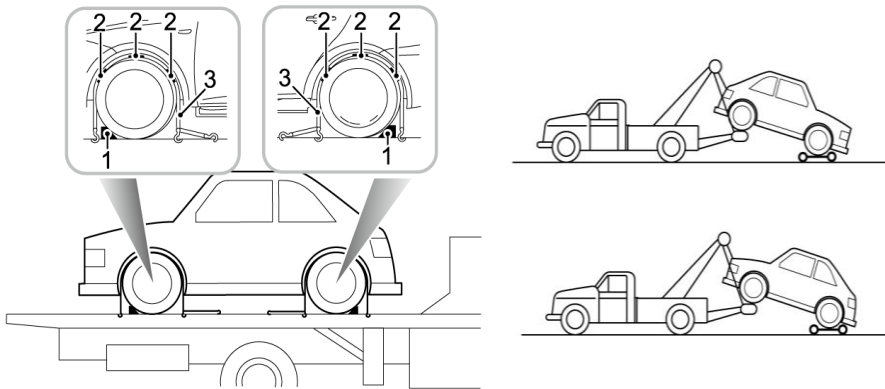

•The vehicle can be towed from the site only when you make sure there is no safety risk. If the battery pack is deformed, leaks, smokes, etc., the safety risk should be solved first.

•When using a transporter to ship the vehicle always ensure the parking brake is applied.

To transport the vehicle on a transporter or trailer, fit wheel chocks (1) as shown, then position the anti slip rubber blocks (2) around the circumference of the wheel. Meanwhile, fit the lashing straps (3) around the wheels and secure them on the trailer. When towing a vehicle, suspended towing is the best method. The driven wheels MUST be suspended above the ground. Please consult the Owner's Handbook for detailed instructions.

## 10. Explanation of Pictograms Used

	Electric Vehicle		Warning, Electricity		Airconditioning component		Lifting point		Use thermal Infrared camera
	Steering wheel, tilt control		Seat adjustment, longitudinal		Seat height adjustment		Use water to extinguish the fire		Hazardous to human health
	Flammable		Corrosives		Explosive		Acute toxicity		RHD vehicle

ID Nr.	Version Nr.	Version date	page
MG 4 Electric	1.0	07/2022	Page 4 of 4