

ARTICLES GOVERNING THE 2024-2025 Summerset GT New Zealand Race Championship

Preamble

Motorsport New Zealand Inc hereby declares the following articles to be those governing Competitors in the Summerset GT New Zealand Race Championship.

These articles are at all times to be read in conjunction with:

- The National Sporting Code (NSC) and its appropriate Appendices and Schedules, specifically Appendix Four, Schedule Z – Races
- The Technical Regulations – Schedule GT
- The Event Supplementary Regulations issued by the Inviting Clubs.

The Championship is held under a MotorSport New Zealand Sanctioning Permit No: **249010**

CONTENTS:

	<u>Official Record of Amendments issued to these Articles</u>	<u>Page 2</u>
1	<u>Interpretations</u>	<u>Page 2</u>
2	<u>Eligibility</u>	<u>Page 2</u>
3	<u>Championship Personnel</u>	<u>Page 3</u>
4	<u>Championship Entry</u>	<u>Page 5</u>
5	<u>Championship Structure</u>	<u>Page 6</u>
6	<u>Championship Format</u>	<u>Page 6</u>
7	<u>Balance of Performance Compulsory Pit Stop</u>	<u>Page 8</u>
8	<u>Parc Ferme</u>	<u>Page 9</u>
9	<u>Race Radio</u>	<u>Page 9</u>
10	<u>Penalties</u>	<u>Page 9</u>
11	<u>Tyre Type, Allocation, and Marking Procedures:</u>	<u>Page 11</u>
12	<u>In Car Judicial Cameras</u>	<u>Page 12</u>
13	<u>Points</u>	<u>Page 12</u>
14	<u>Awards</u>	<u>Page 13</u>
15	<u>Pit Space Allocation</u>	<u>Page 13</u>
Appendix One	<u>Decal Diagram</u>	
Appendix Two	<u>Penalty Schedule</u>	

OFFICIAL RECORD OF AMENDMENTS ISSUED TO THESE ARTICLES

MotorSport NZ may issue amendments to these Championship Articles or Technical Schedule where it is deemed necessary to amend or clarify any article. These amendments will be issued by the Chief Executive Officer or their representative in the form of Championship Amendments.

This table records all official Amendments issued during the season relative to these Articles;

Amendment Number	Issue/Effective date	Article reference	Subject / Notes

1. INTERPRETATIONS:

In these Articles, the definition of terms used within this Schedule shall be referenced from the National Sporting Code, and as detailed below:

“**CPS**” means Compulsory Pit Stop, and

“**The Championship**” means the Summerset GT New Zealand Championship for vehicles complying with Schedule GT New Zealand Championship Technical regulations; and

“**Round Organiser**” or “**Inviting Club**” means the MotorSport NZ Member Club organising a Meeting and/or Event which is a round of the Championship; and

“**Round**” means each Meeting and / or Event - the results of which qualify for points in the Championship.

2. ELIGIBILITY:

2.1 DRIVER ELIGIBILITY:

2.1.1 All Drivers shall hold a C1 Grade Competition Licence or higher and if the Entrant is other than one of the registered Drivers, an Entrant’s Licence is required in the name of the Entrant.

Note: *Under the provisions of the Trans-Tasman Visa Agreement between Motorsport Australia and MotorSport New Zealand Inc, Australian Competitors holding both Motorsport Australia Circuit Competition Licences and Trans-Tasman Visas may enter any of the New Zealand Race Championships and be eligible for awards.*

2.1.2 Foreign participants may compete in the Championship in accordance with Appendix One, Schedule L, Article 6.1.

2.1.3 All drivers and entrants must be financial members of an affiliated MotorSport NZ Club, with the exception of those competing on a Trans-Tasman Visa, or Foreign Participation Visa.

2.1.4 There are four classes for drivers:

- (1) **OPEN:** Drivers using Class 1 vehicles.
- (2) **GT4:** Drivers using Class 2 vehicles.
- (3) **JUNIOR PRO:** - Drivers under 25years of age using Class 3 vehicles.
- (4) **MASTERS:** - for drivers over 55 years of age using Class 2 vehicles.

2.1.5 No Elite-drivers are permitted to compete in the **OPEN, GT4 or MASTERS** Championship.

2.1.6 Elite drivers may compete in the Junior-Pro category provided they are under 25 years old.

2.1.7 An elite-driver is based on the shared list maintained by the North Island Endurance Racing Drivers Club, and South Island Endurance Racing Drivers Club. Intending drivers are advised to check with Championship Co-ordinator for eligibility before registering for the Championship.

2.1.8 **Driving Team:** Each entry may consist of up to two(2) drivers.

2.1.9 One of the registered Drivers or Entrant for each Vehicle must hold a GT New Zealand Championship Racing Entitlement Licence, applied for via the Championship Coordinator.

2.2 **VEHICLE ELIGIBILITY:**

2.2.1 Eligibility shall be for vehicles complying with Schedule GT.

2.2.2 All Competitors shall agree to submit their vehicle for eligibility and/or safety scrutineering inspections as and when required by the appointed Championship Scrutineer, and/or a MotorSport NZ licensed Technical Officer. Any costs incurred during disassembly of components shall be met and accepted by the Competitor.

2.3 **VEHICLE CLASSES:** There are **three** classes as follows and as noted in Schedule GT New Zealand Championship:

- (1) **OPEN:** being those vehicles eligible as listed in Article 2.1.1 of Schedule GT.
- (2) **GT4:** being those vehicles eligible as listed in Article 2.1.2 of Schedule GT, **running GT4 BOP specifications.**
- (3) **JUNIOR PRO:** Porsche 992 and 991 vehicles only with no ABS or Traction control.

2.4 All competing vehicles shall reserve the spaces for the Championship sponsors' and official Championship decals at all Rounds, of which will be provided by the Championship.

All competitors shall carry competition numbers and competitor's name in the locations and to the dimensions set out in Appendix One to these Articles.

Note: *The Championship Coordinator may permit variation of decal location for individual vehicles upon application.*

3. CHAMPIONSHIP PERSONNEL:

3.1 At each Round of the Championship the following personnel shall have the responsibilities and authorities as set out below.

3.1.1 The appointed Championship personnel may have deputies and assistants to whom they may delegate any of their responsibilities and authorities by way of Bulletin posted on the Official Notice Board at each Round.

3.1.2 **Championship Coordinator:** Grant Smith
Mobile Phone No: 021 640999
Email: gtnzchampionship@gmail.com

Who shall have the duties and authority of a Championship Coordinator as set out in the National Sporting Code and who is responsible for and authorised on the Championships behalf to:

- (a) Deal with all administrative matters pertaining to the Championship, and
- (b) Record and publish all Championship points schedules, and
- (c) Liaise with Inviting Club/s on all matters pertaining to these Articles, and
- (d) Ensure correct placement of decals on vehicles contesting the Championship, and
- (e) Provide and/or assist the Inviting Club/s with grid starting positions in accordance with Article 6.4 of these Articles, and
- (f) Calculate and publish CPS times, and
- (g) Attend Steward's meeting if requested.

3.1.3 **Race Director:** Amy Pullen
Mobile Phone No: 021 198 3066
Email: pulla106@yahoo.co.uk

Who is appointed and authorised by MotorSport NZ to be responsible for:

- (a) Ensuring compliance with MotorSport NZ National Sporting Code and its addendums, and this Schedule.
- (b) Undertaking duties and authorities outlined in NSC 78 & 79.
- (c) Conducting Race Director briefing sessions.
- (d) Liaising with the Championship Promoter regarding promotional activities.
- (e) Conducting any inquiries necessary (including any hearings and inquiries held outside of Rounds of the Championship) to resolve any issues and imposing any penalties arising therefrom that may arise during the conduct of the Championship.
- (f) Judge of Fact (Starts)
- (g) Judge of Fact (Yellow Flag redressing)

3.1.4 Deputy Race Director: If appointed, person(s) will be named in the supplementary regulations of the event

Who is appointed and authorised by MotorSport NZ to be responsible for:

- (a) Undertaking duties as delegated by the Race Director; and
- (b) Judge of Fact (Starts); and
- (c) Judge of Fact (Yellow Flag redressing).

3.1.5 Driving Standards Observer: Richard Moore
Mobile Phone No: 021 834 820
Email: richard@downforce.co.nz

Who is authorised by MotorSport NZ to undertake the duties outlined in Schedule Z, Article 22.

3.1.6 Championship Scrutineer: Cymon Hewitt
Mobile Phone No: 027 222 9277
Email: d6motorsport@hotmail.com

Who shall have the authority of a Series Scrutineer set out in the National Sporting Code and who is responsible for and authorised on the Championship's behalf to:

- (a) Deal with all technical matters pertaining to the Championship; and
- (b) Affix official seals, and conduct tyre marking, as and when deemed appropriate; and
- (c) Inspect any competing vehicle within the Championship in order to ascertain compliance with the technical and eligibility regulations; and
- (d) Assist competitors with technical enquiries relative to the technical regulations applicable to their vehicle; and
- (e) Undertake the duties of a Technical Judge (NSC 86(d)) with respect to weights and measures; and
- (f) Liaise with event Officials and Championship Coordinator on any scrutineering or technical conformity issue for the category; and
- (g) To report, to the Race Director, any instances where a breach of the technical regulations has been identified.

4. CHAMPIONSHIP REGISTRATION:

4.1 Registration into the Championship shall be made via email through the Championship Coordinator in the form of an annual series exclusive GT New Zealand Championship Racing Entitlement Licence.

4.1.1 For two-driver teams, one of the registered Drivers or Entrant for each Vehicle must hold a GT New Zealand Championship Annual Series Racing Entitlement Licence, applied for via the Championship Coordinator.

4.1.2 The annual series exclusive GT New Zealand Championship Racing Entitlement Licence of \$6,000 plus GST is payable to secure registration into the Championship. Any registration will not be deemed valid until payment is received.

4.1.3 The Championship Coordinator reserves the right to accept or decline registration into the Championship.

4.2 In registering for the Championship, all Drivers / Entrants:

- (1) Are deemed to be in acceptance of these Articles as they are presented, and
- (2) Agree to comply with these Articles and those of the National Sporting Code, and
- (3) Shall be at all times responsible for the presentation of their competing vehicle with respect to safety requirements under Schedule A, and eligibility requirements under these Championship Articles, and
- (4) Shall comply with any specific requirements of the official Championship Sponsor(s), as detailed within these Championship Articles.

4.3 Entry to each Round of the Championship (which is separate to the Championship Registration) should be made via email through the Championship Coordinator.

4.3.1 Entry fees per Round per vehicle will be \$4,800 plus GST per round, or \$18,000 plus GST if committing to all five Rounds in the Championship and payment received prior to the commencement of the Championship. Any entry will not be deemed valid until payment is received.

These fees include Friday Practice, relevant levies, TV coverage, pit marquee or garage, VIP drivers lounge and VIP hospitality for three people. Hospitality may not be possible /available at every round. An optional reduced entry fee is payable if no VIP Hospitality required. Contact the Championship Co-ordinator for details.

4.4 There will be no refunds given once an entry has been processed. Credits against future competition will be considered in exceptional circumstances.

4.5 Competition numbers are to be allocated by the Series Coordinator, while the Competitor shall provide the physical competition number sets.

5. CHAMPIONSHIP STRUCTURE:

5.1 The Championship shall comprise the following Rounds:

Round	Date	Venue	Inviting Club
1	22-24 November 2024	Taupo	MotorSport New Zealand
2	17-19 January 2025	Hampton Downs	MotorSport New Zealand
3	31 January - 2 February 2025	Teretonga	MotorSport New Zealand
4	7-9 February 2025	Highlands	MotorSport New Zealand
5	21-23 March 2025	Hampton Downs	MotorSport New Zealand

5.2 The Organiser reserves the right to either cancel or amend any Rounds of the Championship due to force majeure without affecting in any way its power to award any title.

6. CHAMPIONSHIP FORMAT:

- 6.1 Practice:** For all Rounds there will be a minimum of two(2) practice sessions of thirty(30) minutes duration. The Driver(s) may only use their competition vehicle which they have entered in the Round in these sessions.
- 6.2 Qualifying:** At all Rounds there will be one (1) qualifying session of a minimum of thirty (30) minutes duration.
- 6.3 Races:** There shall be three(3) races at each round; two thirty minute races, and one sixty minute race. The order of these races will be advised in the event schedule for each Round.
- 6.3.1** Where an entry consists of two(2) drivers:
- (1) Unless specifically permitted by the Race Director, both drivers shall participate in either the Practice or the Qualifying session.
 - (2) Either Driver can start Race One, regardless of who participated in Qualifying.
 - (3) Each Driver must individually compete in one of the thirty-minute Races, and
 - (4) Both must compete in the sixty-minute race.
- 6.4 Races:** shall be run to the following race structure:
- (1) **Race One:** Starting positions will be determined by the fastest lap times achieved from Qualifying Session with the fastest Competitor to the front.
 - (2) **Race Two:** Starting Positions for Race Two will be determined by the finishing positions from Race One.
 - (3) **Race Three:** Starting Positions will be determined by the combined Race Points gained by the driver(s) in Races One and Two at that Round, with the highest scoring driver to the front. In the case of equal Race Points at that Round, the fastest lap recorded by the tied competitors in either qualifying, Race One or Race Two will be used to allocate the higher position. In the instance of an outstanding inquiry or protest 60 minutes prior to the expected race start, the provisional results will be used to calculate points.
- 6.5 Race Starting Procedures:** At all Rounds, all Races will be a Rolling Start as follows:
- (1) When instructed by an official, each Vehicle will leave pit lane for one(1) positioning lap to the grid. Drivers must not stop to carry out a practice start during this lap including when leaving Pit Exit. When a Vehicle arrives at the grid it must stop in its allocated position.
 - (2) When the pole vehicle is in place, a warning will be sounded and a “2 Minute” board displayed by the Starter. Pit Lane exit will be closed at this time.
 - (3) When 1 minute remains before the formation laps, a warning will be sounded and a “1 Minute” board displayed by the Starter.
 - (4) Any Vehicle not having reached the pit entry by the “1 minute” signal must enter the Pit Lane from where they may start the race under the direction of an official after the field has passed.

- (5) When 30 seconds remain before the formation laps, a warning will be sounded and a “30 Second” board will be displayed by the Starter.
- (6) When the green signal is displayed by the Starter, each Vehicle may then proceed on to two formation laps. The field will be picked up by the Safety Car on the second lap.
- (7) Schedule Z 8.4 (2) and (3) shall then apply.

6.6 At all Rounds, the Championship Coordinator in conjunction with the Race Director(s) and/or the Stewards of the Meeting, reserves the right to shorten and / or cancel any practice / qualifying sessions and / or Races in the case of Force Majeure.

6.7 Meeting Rides may be run as advised in the Event Supplementary Regulations and shall be conducted in accordance with the MotorSport NZ Meeting Ride Policy.

7. BALANCE OF PERFORMANCE COMPULSORY PIT STOP

7.1 During the 60 minute race, there will be a Balance of Performance Compulsory Pit Stop (CPS), the duration of which will be determined by the Championship Coordinator.
There will be no Compulsory Pit Stop in either of the 30 minute races.

7.1.2 Drivers will be notified of their Compulsory Pit Stop duration no later than thirty (30) minutes prior to the start of the race.

7.1.3 The CPS may NOT be carried out under Safety Car conditions. Any vehicle that has already entered pit lane at the time the Safety Car is deployed may still complete their CPS.

7.2 Sixty Minute Race:

- (a) The CPS shall take place between twenty(20) and forty(40) minutes from the start of the race and shall commence when the Vehicle comes to a complete stop outside their pit bay.
- (b) Where there is one(1) Driver entered, the driver must remain in the vehicle with their safety harness fully fastened.
- (c) Where there are two(2) Drivers entered, a driver change shall take place during the CPS.
- (d) The Vehicle may not leave after the CPS until the driver’s safety harness has been fully refastened.
- (e) Should the Safety Car be deployed during the CPS window, the Race Director may extend the CPS window.

7.3 Each driver is responsible for determining how their timed CPS is managed.

7.4 In the event of a dispute or an inquiry into a competitor complying with the stipulated stationary-time, the vehicle's camera recording may be used to determine the length of the stop.

- 7.5** The only permitted intervention with the vehicle during the timed CPS will be:
- (i) a Driver change (if applicable) in accordance with Article 7.3(c).
 - (ii) rolling the car back and forwards no more than 2 metres (the vehicle cannot be moved ahead of the point at which it stopped for the Pit Stop) to disperse brake heat. Tyre pressures may be checked and adjusted, and external cooling fans can also be used to disperse heat from the radiators and brakes. Drink bottles may be topped up or changed.
 - (iii) In addition to 7.5 (i) and (ii), changing tyres will be permitted.
- 7.5.1** Any other intervention with the vehicle can only occur when the CPS is complete.
- 7.6** There shall be no refueling of the vehicle during the race.
- 8. PARC FERMÉ:**
- 8.2** Upon directive from the Championship Scrutineer or their appointed assistant, Competitors may be required to drive their competing vehicle directly (and without any team personnel / crew intervention) from the track to the designated Parc Fermé, the location of which will be notified on the official notice board of the Meeting.
- Note:** *Drivers should ensure that they and all their team personnel are familiar with the Parc Fermé regulations and limitations as detailed in the National Sporting Code Article 60.*
- 8.3** The Championship Scrutineer may authorise the entry of team personnel for the purposes of vehicle eligibility inspections.
- 8.4** Unless the Championship Scrutineer consents in each case, any car unable to proceed to Parc Fermé under its own power must nevertheless be delivered there as soon as practicable.
- 9. RACE RADIO**
- 9.2** Race Radio is compulsory and will be used for all major announcements, including race penalties and to communicate with team managers and drivers concerning incidents and circuit penalties.
- 9.3** The frequency is 489.681250 colour code 10 Digital.
- 9.3.1** Any race radio tuned to the above frequency must be set to “receive” only.
- 9.4** Any announcement over Race Radio will be considered as having been heard and understood by teams and drivers. These announcements are decisions and are binding and will be additional to flag/light signals to drivers.

10. PENALTIES

10.2 Penalties shall be applied in accordance with the prescribed articles of NSC Part VIII – Penalties, Schedule P, and Appendix Two to these articles.

10.3 Championship Demerit Points: These penalty points are deemed to be additional to any Time Penalty or Drive Through Penalty that may have been imposed. These points are cumulative over all **Rounds of the Championship** Series. Grid or race exclusion requirements will be imposed once the grid for a race has been determined.

(1) 6 points: Go back six(6) grid places for next race.

(2) 10 points: start from rear of grid for the next race.

(3) 15 points: exclusion from next race and start from rear of grid at following race.

(4) 19 points: exclusion from two (2) races and endorsement of competition Licence until 30 June 2025.

Note: The 'next race' is clarified as being the race a Competitor is starting following a decision being delivered.

10.4 Competitor clearance: If Competitors are required for inquiries or hearings, they will be advised by summons or notice, as applicable. Additionally, an announcement may be made on race radio. These notifications will be made within one(1) hour following completion of the category's final race for the day/Meeting. No Competitor may leave the Circuit until one(1) hour after the finish of their last race on the day.

10.3.1 Any Competitor so notified must receive clearance from the Race Director or Chairman of Stewards prior to leaving the Circuit.

10.3.2 Any Competitor who lodges a protest into any matter must receive clearance from the Chairman of Stewards prior to leaving the Circuit.

10.3.3 Subsequent non-attendance of a Competitor will not stop any hearing proceeding and a decision being taken. It is the responsibility of the relevant official or Competitor to ensure their witnesses are available and able to take part in the hearing.

10.5 Stewards extended powers:

10.4.1 The Stewards shall have extended powers to deal with any matters that arise in relation to the Championship between Meetings. A Stewards' panel may be convened by MotorSport NZ at any time during the Series to consider any protest or other matter within their jurisdiction in relation to the Championship which may be referred to them, or which may be initiated by the Stewards on their own volition.

10.4.2 When the Stewards have commenced a hearing at one place, and it is deemed by them not practicable to complete consideration of that matter at that time and place, the hearing may be adjourned to another time and place and may be heard by a panel of Stewards other than those who commenced the hearing, provided at least one(1) Steward who was at the original hearing is a member of the new panel. If required, the panel will be appointed by MotorSport NZ.

10.4.3 The Stewards may call upon any witness or advisor they so decide, either as part of, or outside, a hearing to assist in resolution of any matter.

- 10.4.4** The Stewards maximum fine level is raised to \$10,000 for any offence. Additionally, they may, for any offence, impose the penalty of exclusion from the Meeting or Event and endorse a Competition Licence for a maximum period of twelve (12) months.
- 10.4.5** If at the conclusion of a hearing the Stewards consider that the matter has been proven and the penalty prescribed in Appendix Two is insufficient given the serious nature of the offence then in such instances the matter may be passed to MotorSport New Zealand for action.

11. TYRE TYPE, ALLOCATION AND MARKING PROCEDURES:

11.2 Only the control tyre (dry and wet specification) as per Schedule GT, Article 11 are permitted for use at any Round of the Championship.

11.2.1 The control tyres must be purchased from the approved provider who will also provide trackside support and fitting services.

European Technique

Name: Wayne Scott
Email: wayne@tracktyres.co.nz
Mobile: +64 27 5389237

11.2.2 Only dry control tyres that have been specifically marked for the current Championship may be used. The tyres will be marked for use on a specified competition vehicle and must be fitted to the wheel in accordance with the manufacturer's specifications. This includes direction and asymmetry. If the tyre supplier doesn't have the specification or tyre size available, they can introduce another option in correspondence with the Championship organisers.

Note: *It is not a requirement to have the control wet tyres marked.*

11.2.3 In the event of wet or damp conditions at the start of or during a Practice, Qualifying session or race, at the discretion of the Competitor(s), it is permitted to use wet specification tyres. The vehicle's rain light must be illuminated.

11.1 New "Dry" tyre allocation: The maximum number of new dry tyres at each round is eight (8) PLUS any previously marked control tyres from the current championship except for Round one where (ten) 10 new dry tyres may be used.

11.1.1 If a dry tyre is damaged, the Championship Scrutineer, in consultation with the approved provider's representative, shall determine the suitability of any (dry) replacement control tyre that has not been marked for the current Championship.

11.2 "Wet" Tyre allocation per Round: There is no controlled allocation of wet tyres per Round. If the meeting is declared "wet" by the Race Director only "wet" specification tyres must be used.

11.3 Tyre marking: Tyre marking (tyre bar code reading) will take place outside the competitors pit garage at each round one hour prior to Qualifying. Any change in time for this will be advised by the Championship Coordinator. It is the responsibility of the competitor to have their tyres ready and clean for marking by this time.

- 11.3.1** It is the Competitor's responsibility to ensure that tyre markings remain clearly visible. Whenever a tyre marking starts to become illegible, the Competitor must advise the Championship Scrutineer accordingly, who will decide upon the appropriate course of action.
- 11.4** It is the responsibility of the competitor to keep a record of all tyres used in the championship by bar code and the meeting where they were used. This list must be made available to championship officials on request.
- (1) In all instances, Tyre Marking references a unique identifier in the form of either a physical Tyre Marking or the scanning of the Tyres Bar Code or both.

11.5 Tyre use during Practice:

Any eligible tyre as outlined in Schedule GT may be used during practice, and do not require marking.

- 11.6** The use of any tyre heating, heat retention device or chemical treatment is prohibited.

12. IN-CAR JUDICIAL CAMERAS

- 12.1** All GT New Zealand Championship vehicles will be required to carry an approved in-vehicle camera, which shall be supplied by the competitor. The position of fitting this camera takes precedence over any other camera fitted in the vehicle.
- 12.2** This camera must be mounted in accordance with Schedule A, Part One Article 6.4 and must be forward facing to capture both the steering wheel and the front view from the front windscreen.
- 12.3** It is the Competitors responsibility to ensure the camera is switched on and recording during all Practice, Qualifying and Race Sessions. For cameras not recording, a Penalty may be applied.
- 12.4** Any on-board camera footage and information recorded shall be made available to Championship Officials upon request. Such recordings shall be retained and unmodified in any way for a minimum of fourteen(14) days after the conclusion of the event.
- 12.5** All rights to all camera footage remains the property of the Championship at all times.
- 12.6 Access to Television Outside Broadcast Facility and footage:** No Entrant, Driver or team member shall be permitted to access the television 'Outside Broadcasting' facility or gain access to any footage directly from the broadcaster during an Event, without obtaining the express permission of the Race Director(s) or the Chairman of Stewarding Panel.

13. POINTS:

- 13.1** Points will be allocated to Drivers in the Vehicle as follows:
- 13.1.1** Where an entry consists of one(1) Driver, points will be allocated based on their highest finishing position in Race One, Race Two and Race Three.
- 13.1.2** Where an entry consists of two(2) Drivers, points will be allocated based on the finishing position of the car in each Race irrespective of which driver was driving the car.

- 13.2** Junior Pro Each Class will have points awarded based on finishing positions within each Race, as follows:

Placing	Points	Placing	Points	Placing	Points
1 st	75	11 th	30	21 st	10
2 nd	67	12 th	28	22 nd	9
3 rd	60	13 th	26	23 rd	8
4 th	54	14 th	24	24 th	7
5 th	49	15 th	22	25 th	6
6 th	45	16 th	20	26 th	5
7 th	42	17 th	18	27 th	4
8 th	39	18 th	16	28 th	3
9 th	36	19 th	14	29 th	2
10 th	33	20 th	12	30 th	1

- 13.2.1** Points allocations will be increased by 50% for the sixty-minute race.

14. AWARDS:

- 14.1** The Class Championship winners for Class Open, Class GT4, Class Master and Class Junior-Pro shall be the Driver with the highest Class points score awarded from all Rounds of the Championship.

- 14.2** The presentation of Championship Awards for Open and GT4 Class shall be made at the conclusion of the Championship at the Motorsport New Zealand Annual Awards Function.

- 14.3** Each class will be awarded 1st, 2nd and 3rd overall according to the results of the Championship.

15. PIT SPACE ALLOCATION:

- 15.1** A marquee or pit garage where available will be allocated by the Championship Coordinator to each Competitor. The Championship Coordinator will issue a notice regarding the terms and conditions of use of all marquees and/or pit garages prior to the commencement of the Championship.

- 15.1.1** The Championship Coordinator will allocate an area in pit lane for each competitor when they are not in a pit garage.

- 15.2** Except when required as part of the programme, or for approved technical reasons, Competitors are to have their competition vehicles in this area, for each Round from:

(a) **Saturday:** 9am - 5pm

(b) **Sunday:** 9am until one(1) hour after conclusion of GT New Zealand Championship's last race.

- 15.2.1** The front entrance of the marquee or pit garage must be open during these times with the front of the vehicle facing the front opening, except when a vehicle is involved in a track session.

APPENDIX ONE

Reserved Signage Areas Season 2024/25



LOCATION	SIZE	SPONSOR
Front Upper Windscreen Banner	200mm high	Summerset
Rear Upper Windscreen Banner	160mm high	Summerset
Front bonnet / nose	500mm x 120mm	Michelin
Front Number Plate	360mm x 120mm	Azumit Yachts
Rear Number Plate	360mm x 120mm	Azumit Yachts
L and R Front Bumper Side Panels	TBA	Michelin
Lower Side Sills	TBA	Secondary Series Sponsors
Front guards	TBA	MotorSport NZ Championship decal (supplied)

OPEN CLASS

LOCATION	SIZE / COLOUR	FONT
F and R Windscreen Race Numbers	150mm high Dayglo Yellow	Helvetica Bold
Drivers Name Windscreens	80mm high Dayglo Yellow	Helvetica Bold
Side Window Race Numbers	150mm high Dayglo Yellow	Helvetica Bold

GT4 CLASS

LOCATION	SIZE / COLOUR	FONT
F and R Windscreen Race Numbers	150mm high Dayglo Green	Helvetica Bold
Drivers Name Windscreens	80mm high Dayglo Green	Helvetica Bold
Side Window Race Numbers	150mm high Dayglo Green	Helvetica Bold

Orange areas reserved for series sponsors

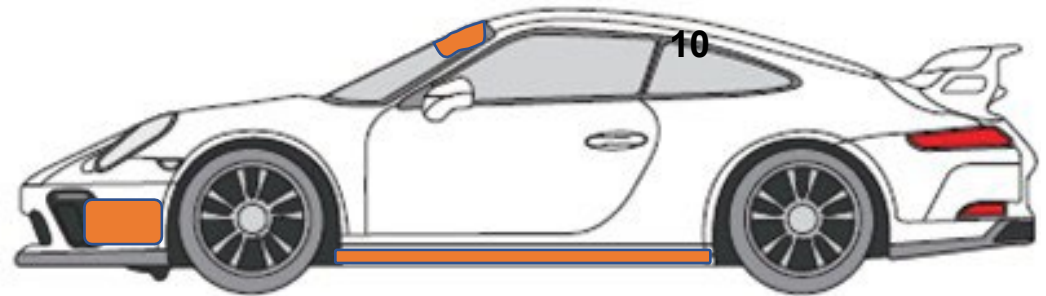
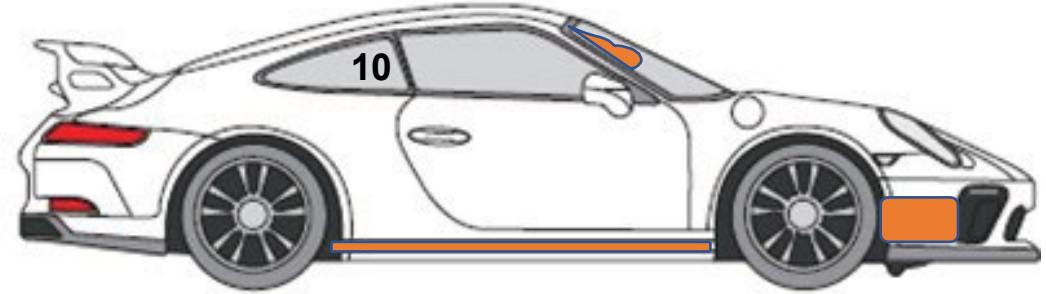
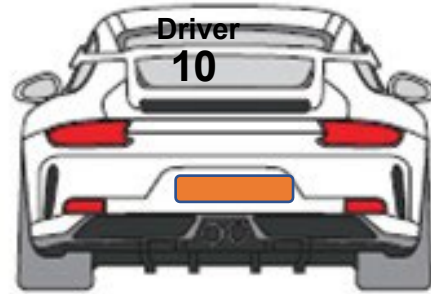
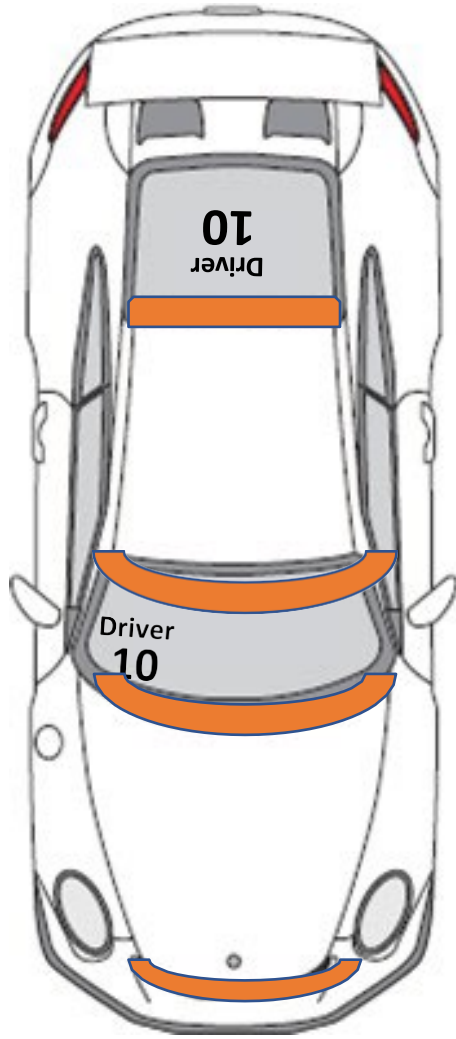

T

Orange areas reserved for series sponsors

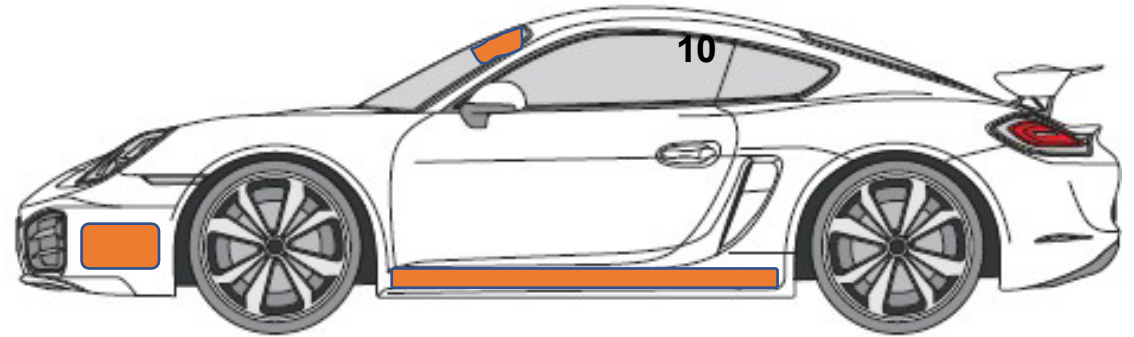
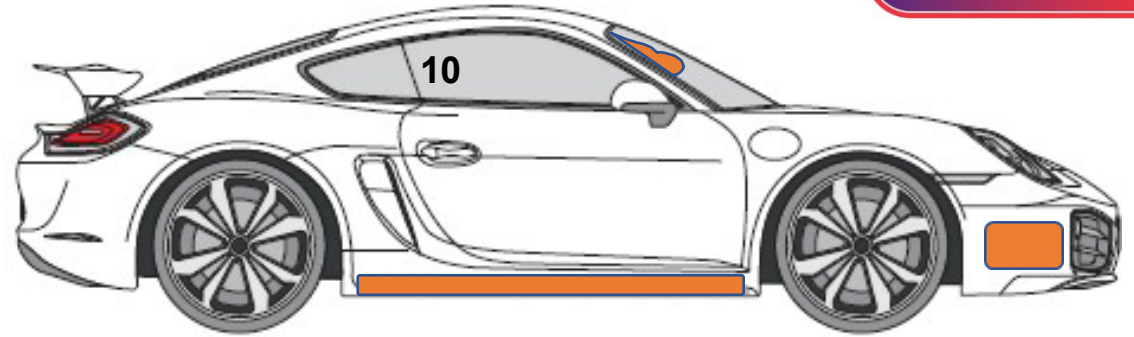
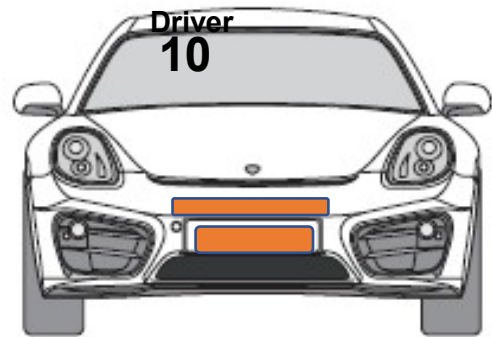
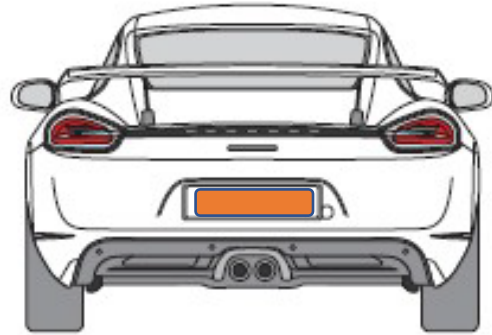
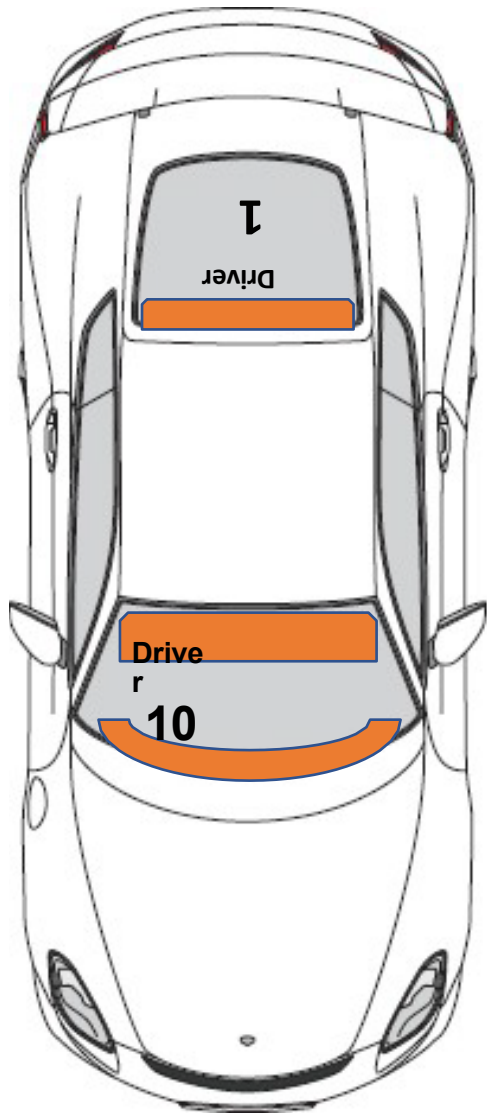

Orange areas reserved for series sponsors

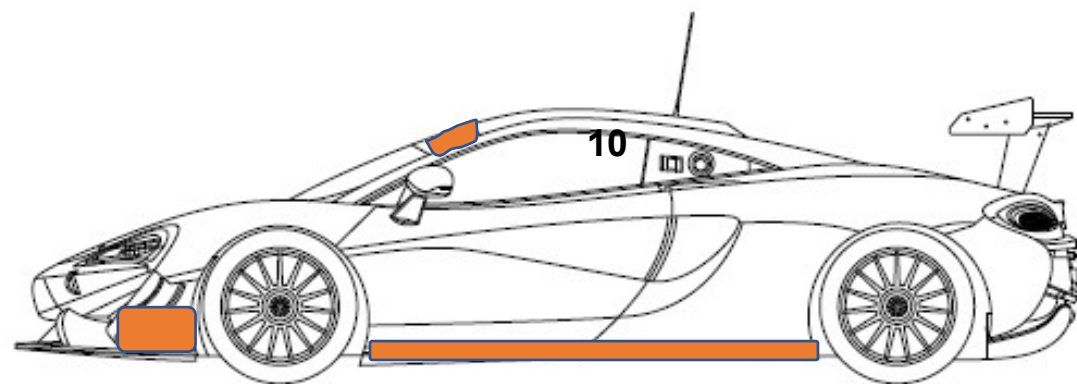
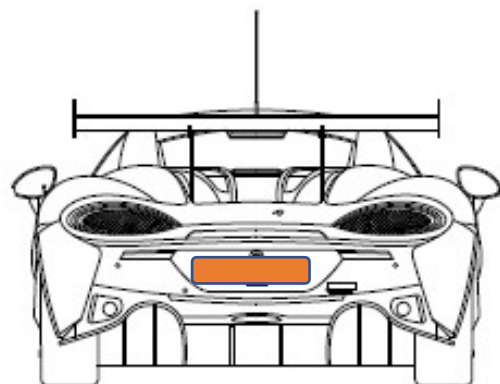
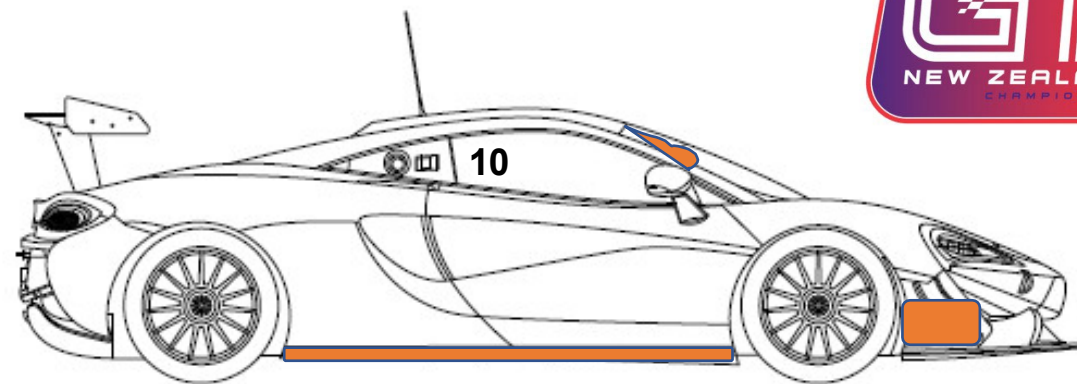
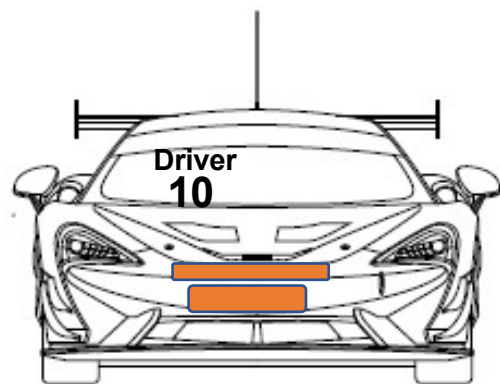
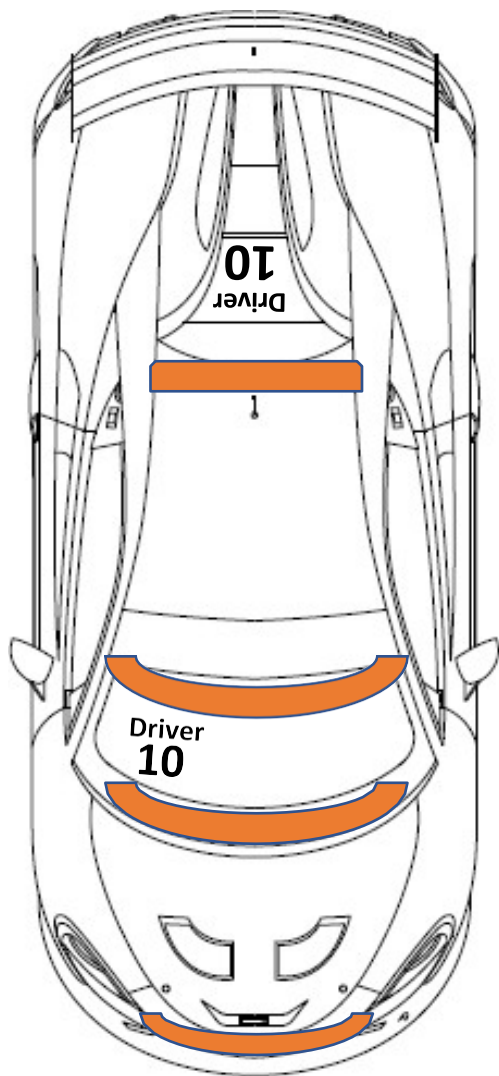

4672mm

A2. Penalty Schedule

A2.1 Unless specified in this Appendix, penalties and conditions outlined in Schedule P will apply.

Where a penalty in this Schedule applies then it shall override the equivalent penalty contained in Appendix One, Schedule P. All other sections of Schedule P will continue to apply when not at variance with this table.

For those offences listed with an asterisk (*), a Drive Through Penalty may be replaced by a penalty of thirty(30) seconds to race time. Demerit points will still be applied.

CATEGORY OF OFFENCE	STANDARD PENALTIES		SERIES DEMERIT POINTS
	MAXIMUM FINE	PENALTY	
A2.1.1 Failure to submit, when required, to testing for banned substances (as prescribed by Art 38(1) of National Sporting Code, or alcohol breath test	\$10,000	1. Exclusion from Series 2. Suspension of Competition Licence until 30 June 2025.	
A2.1.2 Returning a positive drug test	\$5,000	Immediate suspension of competition Licence and referral to Motorsport NZ	
A2.1.3 Returning a positive alcohol breath test	\$3,000	1. Minimum twelve (12) hour stand down period. 2. Endorsement of competition Licence for minimum of three(3) months and maximum of twelve(12) months	
A2.2 Any of the specific behaviour set out in Art 94(1) of National Sporting Code (i.e. Bribing or attempting to bribe)	\$1,000	Endorsement of competition Licence for minimum of three(3) months and maximum of twelve(12) months	
A2.3 Any of the specific behaviour set out in Art.94(2) of National Sporting Code (i.e. Behaviour concerning entry of competing car or Competitor)	\$3,000	1. Endorsement of competition Licence for minimum of three(3) months and maximum of twelve(12) months and/or 2. Exclusion from Series, Meeting or Event.	

<p>A2.4 Abuse or threatening of an Official or Competitor or another person.</p>	<p>\$5,000</p>	<p>1. Endorsement of competition Licence for minimum of three(3) months and maximum of twelve(12) months and/or May be referred to MotorSport NZ for further action</p>	
<p>A2.5 Breach of any specific requirement or obligation of Driver or Entrant for which no other penalty is specified in this Schedule under: (a) National Sporting Code or (b) Any Appendix or Schedule to an Appendix thereof (c) The Standing Regulations or Supplementary Regulations (if any) of Meeting or Event</p>	<p>\$3,000</p>		
<p>A2.6 Failure to attend driver's briefing (Organisers or Category)</p>	<p>\$300</p>		
<p>A2.7 Submitting a false declaration relating to validity of Civil Drivers Licence (NSC 43(2) refers)</p>	<p>\$1,500</p>	<p>Suspension of competition Licence until 30 June 2025.</p>	
<p>A2.8.1 Failure to Produce: Car logbook at Safety Audit inspection</p>	<p>\$300</p>		
<p>A2.8.2 Failure to produce Car identity papers (Car or safety cage/bar Homologation) when required to do so.</p>	<p>\$300</p>		
<p>A2.9 Competing in or entering competing car not eligible for Meeting or Event under Category Technical Schedule Performance and/or Reliability</p>	<p>\$3,000</p>	<p>1. Exclusion from Meeting or Event or Part of the Meeting or Event. 2. Endorsement of competition Licence for minimum of one(1) month and maximum of twelve(12) months</p>	

<p>A2.10 Competing in or entering competing car not eligible for Meeting or Event under Category Technical Schedule Non-performance and/or reliability</p>	\$1,500		
<p>A2.11.1 Failing to present competing car: For eligibility inspection when required to do so</p> <p>Or</p> <p>A2.11.2 To Parc Fermé when required</p>	\$3,000	Exclusion from Meeting or Event.	
<p>A2.12.1 Failure to have MotorSport NZ official seals fitted.</p>	\$1,000	Exclusion from the Series, Meeting or Event, and Deduction of all Championship or Series points since seal application date.	
<p>A2.12.2 Found to have broken, tampered with or removed MotorSport NZ seals as applied.</p>	\$3,000	Exclusion from the Series, Meeting or Event, and Deduction of all Championship or Series points since seal application date.	
<p>A2.12.3 Found to be ineligible following removal of official seal(s) for technical compliance inspections by an appointed Technical Officer or Series Technical Officer.</p>	\$3,000	Exclusion from the Series, Meeting or Event, and Deduction of all Championship or Series points since seal application Date. and Endorsement of competition Licence for minimum of one(1) month and maximum of twelve(12) months	
<p>A2.12.4 Pushing a car by the driver or by another competing car along the circuit or pushing it across the finishing line</p>	\$1,000	<p><u>Practice and Qualifying</u> Up to five(5) grid place penalty</p> <p><u>Race</u> Exclusion from the race.</p>	3

<p>A2.13.1 Disregard of Red Flag/lights.</p>	<p>\$3,000</p>	<p><u>Practice and Qualifying</u> to be moved up to five(5) grid places back in starting grid for the next race or exclusion</p> <p><u>Race</u> Exclusion from the race</p>	<p>4</p> <p>4</p>
<p>A2.13.2* Failing to slow for Red Flag/lights.</p>		<p><u>Practice and Qualifying</u> to be moved up to five(5) places back in starting grid for the next race.</p> <p><u>Race</u> Up to thirty(30) second time penalty or Pit Lane Drive Through</p>	<p>3</p> <p>3</p>
<p>A2.14.1* Failing to slow for single Yellow Flag/lights.</p>		<p><u>Practice</u> Reprimand or moved back up to three(3) grid places for the next race</p> <p><u>Qualifying</u> to be moved up to three(3) places back in starting grid for the next race.</p> <p><u>Race</u> Up to thirty(30) second time penalty or Pit Lane Drive Through</p>	<p>2</p> <p>2</p> <p>2</p>
<p>A2.14.2* Failing to slow for double Yellow Flags/flashing Yellow lights.</p>		<p><u>Practice</u> Reprimand or to be moved up to five(5) grid places back in starting grid for the next race.</p> <p><u>Qualifying</u> to be moved up to five(5) places back in starting grid for the next race.</p> <p><u>Race</u> Up to thirty(30) second time penalty or Pit Lane Drive Through</p>	<p>3</p> <p>3</p> <p>3</p>

<p>A2.14.3* Overtaking or failing to maintain position under the yellow flag/lights which has not been redressed within one(1) lap</p>		<p><u>Qualifying</u> Loss of fastest Qualifying time in the session</p> <p><u>Racing</u> Up to thirty(30) second time penalty or Pit Lane Drive Through</p>	<p>2</p> <p>2</p>
<p>A2.15 Disregarding the black flag with number or black flag with orange disc.</p>	<p>\$1,500</p>	<p><u>Practice</u> to be moved up to ten(10) places back in starting grid for the next race.</p> <p><u>Qualifying</u> Exclusion from Qualifying session</p> <p><u>Racing</u> Exclusion from Race</p>	<p>4</p> <p>4</p> <p>4</p>
<p>A2.16 Causing Qualifying session to be Red Flagged</p>		<p>To be moved three(3) places back in starting grid for the next race.</p>	
<p>A2.17* Failing to respect Blue Flags/lights.</p>		<p>Up to thirty(30) second time penalty or Pit Lane Drive Through</p>	<p>2</p>
<p>A2.18 Failing to respect Chequered Flag.</p>		<p><u>Practice</u> Reprimand</p> <p><u>Qualifying</u> to be moved up to three(3) places back in starting grid for the next race.</p> <p><u>Race</u> To be moved back five(5) grid places for the next race or up to a thirty(30) second time penalty.</p>	<p>2</p> <p>2</p>
<p>A2.19 * Breach of Code of Driving Conduct (Schedule Z, Article 15)</p>		<p><u>Practice</u> Excluded from the Practice session</p> <p><u>Qualifying</u> to be moved three(3) places back in starting grid for the next race.</p> <p><u>Racing</u> Up to thirty(30) second time penalty or Pit Lane Drive Through, or up to five(5) grid place penalty if the driver failed to finish the race.</p>	<p>Up to 3</p> <p>Up to 3</p> <p>Up to 3</p>

		Post-Race Inquiry: Up to thirty(30) seconds to race time. An additional time penalty may be applied.	Up to 3
A2.20 Careless driving causing or likely to cause an incident	\$2,000	Practice / Qualifying to be moved five(5) places back in starting grid for the next race. Racing A minimum of thirty(30) seconds added to Race time and Endorsement of competition Licence for minimum of one(1) month and maximum of six(6) months.	4 4
A2.21 Dangerous Driving (Performing an act or omission creating very serious risk with deliberate disregard of the consequences)	\$3,000	Exclusion from race, Qualifying or Practice session, or start from the rear of the grid in the next race if the driver failed to finish. and Endorsement of competition Licence for minimum of three(3) months and maximum of twelve(12) months.	5
A2.22* Leaving the Circuit and gaining an advantage		Practice Reprimand Qualifying Loss of lap time of the lap and following lap on which the advantage has been gained. Multiple offences may incur a further time penalty at the discretion of the Race Director Race Up to thirty(30) second time penalty or Pit Lane Drive Through.	0 Up to 2 2
A2.23.1 Breach of formation/positioning lap procedures		Up to five(5) second time penalty	1
A2.23.2 False start.		Up to ten(10) second time penalty. An additional time penalty may be applied.	1

A2.24* Breach of Rolling Start or Safety Car Regulations.		Up to ten(10) second time penalty or Pit Lane Drive Through.	1
A2.25* Undertaking Practice Starts other than as permitted.		<u>Practice</u> Reprimand <u>Qualifying</u> Loss of fastest Qualifying lap <u>Racing</u> Up to thirty(30) second time penalty or Pit Lane Drive Through.	1
A2.26* Weaving after the Safety Car lights are extinguished.		Up to ten(10) second time penalty	1
A2.27* (a) Crossing the pit entry line when not entering the pits, or (b) Crossing the pit exit blend line when leaving Pit Lane.		<u>Qualifying</u> to be moved up to five(5) places back in starting grid for the next race. <u>Racing</u> Up to thirty(30) second time penalty or Pit Lane Drive Through	2 2
A2.28* Failing to stop at Pit Lane red light.		<u>Practice</u> Reprimand <u>Qualifying</u> to be moved three(3) places back in starting grid for the next race. <u>Race</u> Pit Lane Drive Through.	2 2 2

<p>A2.29* Breach of Circuit Regulations</p>		<p><u>Practice</u> Reprimand</p> <p><u>Qualifying</u> Loss of lap time of the lap and following lap on which the breach occurred. Multiple offences may incur a further time penalty at the discretion of the Race Director</p> <p><u>Race</u> Up to thirty(30) second time penalty or Pit Lane Drive Through</p>	<p>0</p> <p>Up to 2</p> <p>2</p>
<p>A2.30 Breach of Parc Fermé regulations</p>	<p>\$1,000</p>	<p>Time penalty of up to thirty(30) seconds. In case of interference, up to exclusion.</p>	<p>1</p>
<p>A2.31 Breach of Category Testing Articles</p>	<p>\$3,000</p>	<p>Start from rear of grid, race one at Circuit where offence has been committed, or next race as appropriate.</p> <p>and</p> <p>Endorsement of Competition Licence until 30 June 2025.</p>	
<p>A2.32* Breach of Pit Lane Speed Limit</p>		<p><u>Practice</u> Reprimand</p> <p><u>Qualifying</u> to be moved three(3) places back in starting grid for the next race.</p> <p><u>Racing</u> Up to thirty(30) second time penalty or Pit Lane Drive Through</p>	<p>2</p> <p>2</p> <p>2</p>
<p>A2.33 Failure to have correct numbers or advertising affixed during Meeting</p>	<p>\$1,500</p>		
<p>A2.34 Breach of Promotional Responsibilities or activities</p>	<p>\$1,500</p>	<p>First Offence – Warning Further Offence – lose of up to five(5) championship points</p>	
<p>A2.35 Additional team personnel on starting grid</p>	<p>\$750</p>		

<p>A2.36 Failure to complete documentation/sign on requirements within specified time frame</p>	<p>\$1,500</p>		
<p>A2.37 Lodgement of 'frivolous or vexatious' inquiry or protest</p>	<p>\$3,000</p>		
<p>A2.38 Failure to complete the prescribed timed CPS in accordance with Article 7 of these Championship Articles</p>		<p>1. A recall to the pitlane via Race Radio to complete the remainder of timed CPS, if identified during the race, or</p> <p>2. If the full prescribed pit stop time is not completed and is discovered after the completion of the race, the remaining time for the prescribed pit stop plus 30 seconds will be added to a driver's time.</p>	
<p>A2.39 Breach for any conditions detailed around the use and operation of judicial cameras in Article 12</p>		<p>During Qualifying: The competitor may be excluded from the Session.</p> <p>During a Race. Up to thirty(30) seconds may be added to the Competitor's race time.</p>	